



HIGH COMMON-MODE VOLTAGE DIFFERENCE AMPLIFIER

FEATURES

- **Common-Mode Voltage Range:** ± 275 V
- **Minimum CMRR:** 84 dB from -55°C to $+125^{\circ}\text{C}$
- **DC Specifications:**
 - **Maximum Offset Voltage:** 3500 μV
 - **Maximum Gain Error:** 0.047%
 - **Maximum Gain Nonlinearity:** 0.001% FSR at 25°C
- **AC Performance:**
 - **Bandwidth:** 500 kHz
 - **Typical Slew Rate:** 5 V/ μs
- **Wide Supply Range:** ± 2.0 V to ± 18 V
 - **Maximum Quiescent Current:** 1100 μA
 - **Output Swing on ± 15 -V Supplies:** ± 13.5 V
- **Input Protection:**
 - **Common-Mode:** ± 500 V
 - **Differential:** ± 500 V

APPLICATIONS

- **High-Voltage Current Sensing**
- **Battery Cell Voltage Monitoring**
- **Power-Supply Current Monitoring**
- **Motor Controls**
- **Replacement for Isolation Circuits**

DESCRIPTION

The INA149 is a precision unity-gain difference amplifier with a very high input common-mode voltage range. It is a single, monolithic device that consists of a precision op amp and an integrated thin-film resistor network. The INA149 can accurately measure small differential voltages in the presence of common-mode signals up to ± 275 V. The INA149 inputs are protected from momentary common-mode or differential overloads of up to 500 V.

In many applications, where galvanic isolation is not required, the INA149 can replace isolation amplifiers. This ability can eliminate costly isolated input side power supplies and the associated ripple, noise, and quiescent current. The excellent 0.0005% nonlinearity and 500-kHz bandwidth of the INA149 are superior to those of conventional isolation amplifiers.

The INA149 is pin-compatible with the [INA117](#) and [INA148](#) type high common-mode voltage amplifiers and offers improved performance over both devices. The INA149 is available in the SOIC-8 package with operation specified over the military temperature range of -55°C to $+125^{\circ}\text{C}$.

SUPPORTS DEFENSE, AEROSPACE, AND MEDICAL APPLICATIONS

- **Controlled Baseline**
- **One Assembly/Test Site**
- **One Fabrication Site**
- **Available in Military ($-55^{\circ}\text{C}/125^{\circ}\text{C}$) Temperature Range⁽¹⁾**
- **Extended Product Life Cycle**
- **Extended Product-Change Notification**
- **Product Traceability**

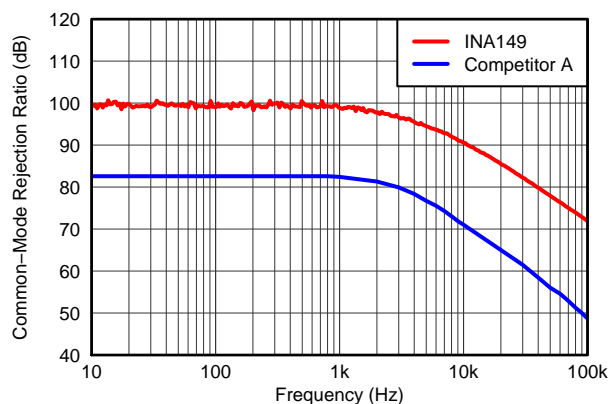

(1) Additional temperature ranges available - contact factory



Please be aware that an important notice concerning availability, standard warranty, and use in critical applications of Texas Instruments semiconductor products and disclaimers thereto appears at the end of this data sheet.

All trademarks are the property of their respective owners.



This integrated circuit can be damaged by ESD. Texas Instruments recommends that all integrated circuits be handled with appropriate precautions. Failure to observe proper handling and installation procedures can cause damage.

ESD damage can range from subtle performance degradation to complete device failure. Precision integrated circuits may be more susceptible to damage because very small parametric changes could cause the device not to meet its published specifications.

PACKAGE/ORDERING INFORMATION⁽¹⁾

T _A	PACKAGE	ORDERABLE PART NUMBER	PACKAGE MARKING	VID NUMBER
-55°C to 125°C	SOIC-8 - D	INA149AMDREP	INA149AM	V62/12614-01XE

(1) For the most current package and ordering information, see the Package Option Addendum at the end of this document, or visit the device product folder at www.ti.com.

ABSOLUTE MAXIMUM RATINGS⁽¹⁾

Over operating free-air temperature range, unless otherwise noted.

		INA149	UNIT
Supply voltage	(V ₊) – (V ₋)	40	V
Input voltage range	Continuous	300	V
Common-mode and differential, 10 s		500	V
Maximum Voltage on REF _A and REF _B		(V ₋) – 0.3 to (V ₊) + 0.3	V
Input current on any input pin ⁽²⁾		10	mA
Output short-circuit current duration		Indefinite	
Operating temperature range		-55 to +125	°C
Storage temperature range		-65 to +150	°C
Junction temperature		+150	°C
ESD rating	Human body model (HBM)	1500	V
	Charged device model (CDM)	1000	V
	Machine model (MM)	100	V

- (1) Stresses above these ratings may cause permanent damage. Exposure to absolute maximum conditions for extended periods may degrade device reliability. These are stress ratings only, and functional operation of the device at these or any other conditions beyond those specified is not implied.
- (2) REF_A and REF_B are diode clamped to the power-supply rails. Signals applied to these pins that can swing more than 0.3 V beyond the supply rails should be limited to 10 mA or less.

THERMAL INFORMATION

THERMAL METRIC ⁽¹⁾		INA149	UNITS
		D (SOIC)	
		8 PINS	
θ_{JA}	Junction-to-ambient thermal resistance ⁽²⁾	110	°C/W
θ_{JcTop}	Junction-to-case (top) thermal resistance ⁽³⁾	57	
θ_{JB}	Junction-to-board thermal resistance ⁽⁴⁾	54	
ψ_{JT}	Junction-to-top characterization parameter ⁽⁵⁾	11	
ψ_{JB}	Junction-to-board characterization parameter ⁽⁶⁾	53	
θ_{JcBot}	Junction-to-case (bottom) thermal resistance ⁽⁷⁾	N/A	

- (1) For more information about traditional and new thermal metrics, see the *IC Package Thermal Metrics* application report, [SPRA953](#).
- (2) The junction-to-ambient thermal resistance under natural convection is obtained in a simulation on a JEDEC-standard, high-K board, as specified in JESD51-7, in an environment described in JESD51-2a.
- (3) The junction-to-case (top) thermal resistance is obtained by simulating a cold plate test on the package top. No specific JEDEC-standard test exists, but a close description can be found in the ANSI SEMI standard G30-88.
- (4) The junction-to-board thermal resistance is obtained by simulating in an environment with a ring cold plate fixture to control the PCB temperature, as described in JESD51-8.
- (5) The junction-to-top characterization parameter, ψ_{JT} , estimates the junction temperature of a device in a real system and is extracted from the simulation data for obtaining θ_{JA} , using a procedure described in JESD51-2a (sections 6 and 7).
- (6) The junction-to-board characterization parameter, ψ_{JB} , estimates the junction temperature of a device in a real system and is extracted from the simulation data for obtaining θ_{JA} , using a procedure described in JESD51-2a (sections 6 and 7).
- (7) The junction-to-case (bottom) thermal resistance is obtained by simulating a cold plate test on the exposed (power) pad. No specific JEDEC standard test exists, but a close description can be found in the ANSI SEMI standard G30-88.

ELECTRICAL CHARACTERISTICS: $V_+ = +15\text{ V}$ and $V_- = -15\text{ V}$ At $T_A = +25^\circ\text{C}$, $R_L = 2\text{ k}\Omega$ connected to ground, and $V_{CM} = \text{REF}_A = \text{REF}_B = \text{GND}$, unless otherwise noted.

PARAMETER	TEST CONDITIONS	INA149			UNIT
		MIN	TYP	MAX	
GAIN					
Initial	$V_{OUT} = \pm 10.0\text{ V}$,		1		V/V
Gain error	$V_{OUT} = \pm 10.0\text{ V}$, $T_A = -55^\circ\text{C}$ to $+125^\circ\text{C}$		± 0.005	± 0.047	%FSR
Gain	vs temperature, $T_A = -55^\circ\text{C}$ to $+125^\circ\text{C}$		± 1.5		ppm/ $^\circ\text{C}$
Nonlinearity			± 0.0005	± 0.001	%FSR
OFFSET VOLTAGE					
Initial offset	$T_A = -55^\circ\text{C}$ to $+125^\circ\text{C}$		350	3500	μV
	vs temperature, $T_A = -55^\circ\text{C}$ to $+125^\circ\text{C}$		2.5		$\mu\text{V}/^\circ\text{C}$
	vs supply (PSRR), $V_S = \pm 2\text{ V}$ to $\pm 18\text{ V}$, $T_A = -55^\circ\text{C}$ to $+125^\circ\text{C}$	90	120		dB
INPUT					
Impedance	Differential		800		k Ω
	Common-mode		200		k Ω
Voltage range	Differential	-13.5		13.5	V
	Common-mode	-275		275	V
Common-mode rejection (CMRR)	At dc, $V_{CM} = \pm 275\text{ V}$, $T_A = -55^\circ\text{C}$ to $+125^\circ\text{C}$	84	98		dB
	At ac, 500 Hz, $V_{CM} = 500\text{ V}_{PP}$		90		dB
	At ac, 1 kHz, $V_{CM} = 500\text{ V}_{PP}$		90		dB
OUTPUT					
Voltage range	$T_A = -55^\circ\text{C}$ to $+125^\circ\text{C}$	-13.5		13.5	V
Short-circuit current			± 25		mA
Capacitive load drive	No sustained oscillations		10		nF
OUTPUT NOISE VOLTAGE					
0.01 Hz to 10 Hz			20		μV_{PP}
10 kHz			550		$\text{nV}/\sqrt{\text{Hz}}$
DYNAMIC RESPONSE					
Small-signal bandwidth			500		kHz
Slew rate	$V_{OUT} = \pm 10\text{-V}$ step, $T_A = -55^\circ\text{C}$ to $+125^\circ\text{C}$	1.7	5		V/ μs
Full-power bandwidth	$V_{OUT} = 20\text{ V}_{PP}$		32		kHz
Settling time	0.01%, $V_{OUT} = 10\text{-V}$ step		7		μs
POWER SUPPLY					
Voltage range		± 2		± 18	V
Quiescent current	$V_S = \pm 18\text{ V}$, $V_{OUT} = 0\text{ V}$		810	950	μA
	vs temperature, $T_A = -55^\circ\text{C}$ to $+125^\circ\text{C}$		0.95	1.1	mA
TEMPERATURE RANGE					
Specified		-55		+125	$^\circ\text{C}$
Operating		-55		+125	$^\circ\text{C}$
Storage		-65		+150	$^\circ\text{C}$

ELECTRICAL CHARACTERISTICS: $V_+ = 5\text{ V}$ and $V_- = 0\text{ V}$

 At $T_A = +25^\circ\text{C}$, $R_L = 2\text{ k}\Omega$ connected to 2.5 V, and $V_{CM} = \text{REF}_A = \text{REF}_B = 2.5\text{ V}$, unless otherwise noted.

PARAMETER	TEST CONDITIONS	INA149			UNIT
		MIN	TYP	MAX	
GAIN					
Initial	$V_{OUT} = 1.5\text{ V to }3.5\text{ V}$		1		V/V
Gain error	$V_{OUT} = 1.5\text{ V to }3.5\text{ V}$		± 0.005		%FSR
Gain	vs temperature, $T_A = -55^\circ\text{C to }+125^\circ\text{C}$		± 1.5		ppm/ $^\circ\text{C}$
Nonlinearity			± 0.0005		%FSR
OFFSET VOLTAGE					
Initial offset			350		μV
	vs temperature, $T_A = -55^\circ\text{C to }+125^\circ\text{C}$		3		$\mu\text{V}/^\circ\text{C}$
	vs supply (PSRR), $V_S = 4\text{ V to }5\text{ V}$		120		dB
INPUT					
Impedance	Differential		800		k Ω
	Common-mode		200		k Ω
	Common-mode	-20		25	V
Common-mode rejection	At dc, $V_{CM} = -20\text{ V to }25\text{ V}$		100		dB
	vs temperature, $T_A = -55^\circ\text{C to }+125^\circ\text{C}$, at dc		100		dB
	At ac, 500 Hz, $V_{CM} = 49\text{ V}_{PP}$		100		dB
	At ac, 1 kHz, $V_{CM} = 49\text{ V}_{PP}$		90		dB
OUTPUT					
Voltage range		1.7		3.4	V
Short-circuit current			± 15		mA
Capacitive load drive	No sustained oscillations		10		nF
OUTPUT NOISE VOLTAGE					
0.01 Hz to 10 Hz			20		μV_{PP}
10 kHz			550		nV/ $\sqrt{\text{Hz}}$
DYNAMIC RESPONSE					
Small-signal bandwidth			500		kHz
Slew rate	$V_{OUT} = 2\text{ V}_{PP}$ step		5		V/ μs
Full-power bandwidth	$V_{OUT} = 2\text{ V}_{PP}$		32		kHz
Settling time	0.01%, $V_{OUT} = 2\text{ V}_{PP}$ step		7		μs
POWER SUPPLY					
Voltage range			5		V
Quiescent current	$V_S = 5\text{ V}$		810		μA
	vs temperature, $T_A = -55^\circ\text{C to }+125^\circ\text{C}$		1		mA

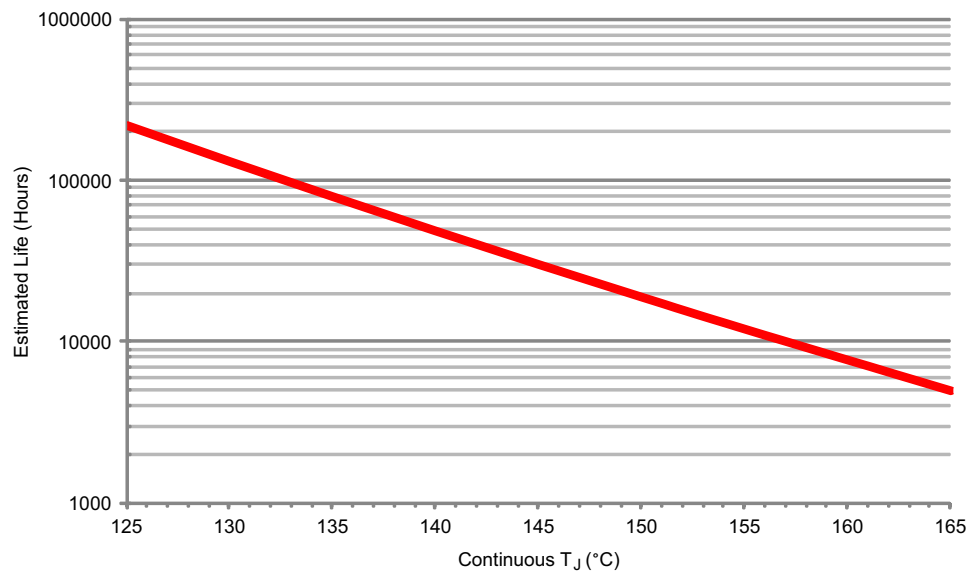

- A. See datasheet for absolute maximum and minimum recommended operating conditions.
- B. Silicon operating life design goal is 10 years at 105°C junction temperature (does not include package interconnect life).

Figure 1. INA149 Wirebond Life Derating Chart

PIN CONFIGURATION

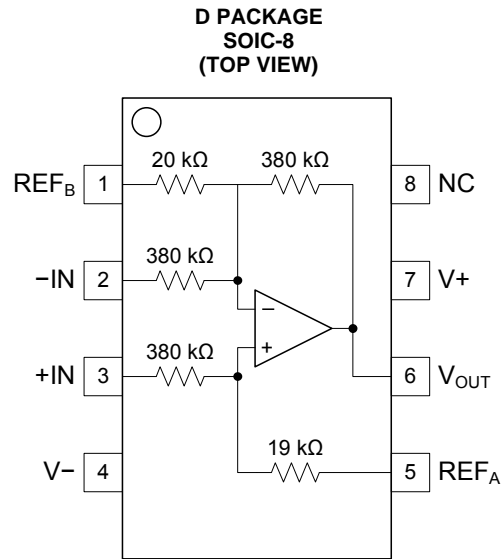

PIN DESCRIPTIONS

NAME	NO.	DESCRIPTION
-IN	2	Inverting input
+IN	3	Noninverting input
NC	8	No internal connection
REF _A	5	Reference input
REF _B	1	Reference input
V-	4	Negative power supply
V+	7	Positive power supply ⁽¹⁾
V _{OUT}	6	Output

(1) In this document, (V+) – (V-) is referred to as V_S.

TYPICAL CHARACTERISTICS

At $T_A = +25^\circ\text{C}$, $R_L = 2\text{ k}\Omega$ connected to ground, and $V_S = \pm 15\text{ V}$, unless otherwise noted.

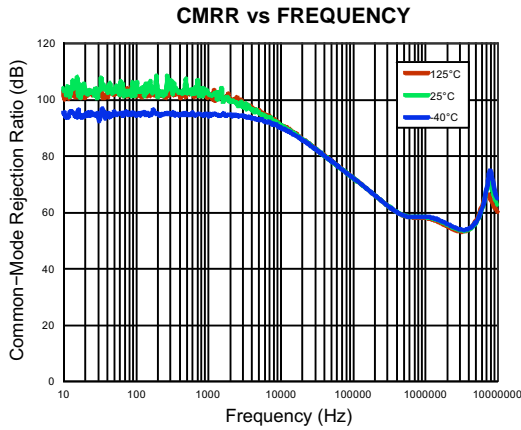

Figure 2.

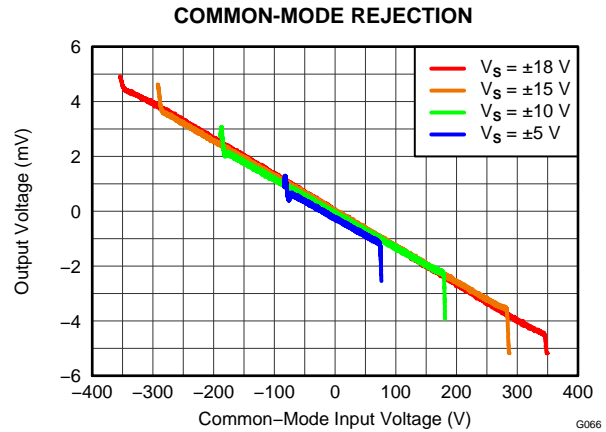

Figure 3.

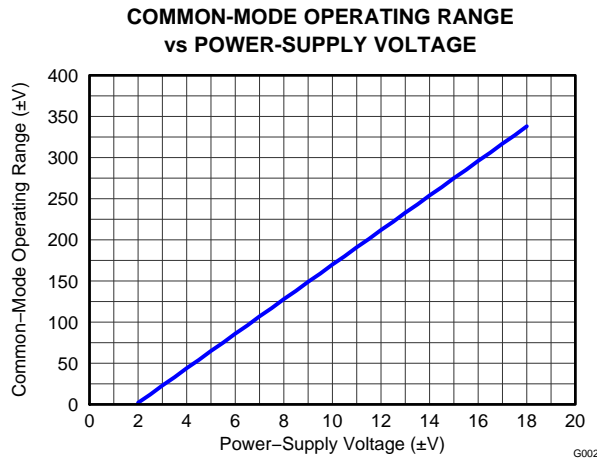

Figure 4.

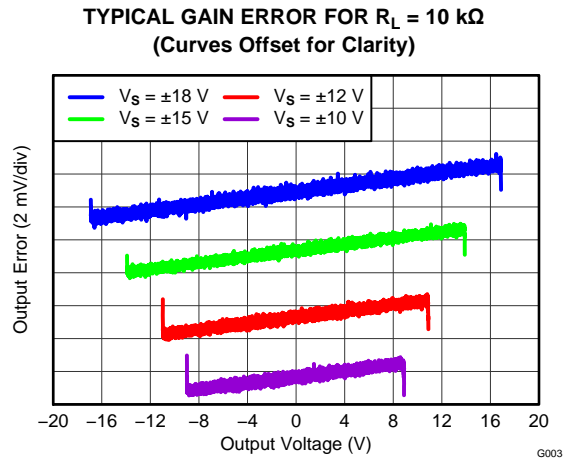

Figure 5.

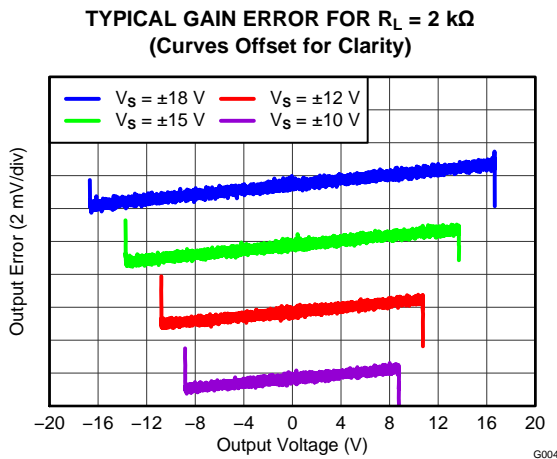

Figure 6.

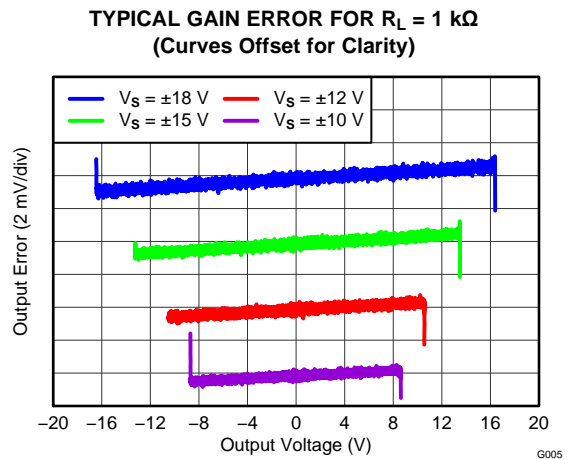

Figure 7.

TYPICAL CHARACTERISTICS (continued)

At $T_A = +25^\circ\text{C}$, $R_L = 2\text{ k}\Omega$ connected to ground, and $V_S = \pm 15\text{ V}$, unless otherwise noted.

TYPICAL GAIN ERROR FOR LOW SUPPLY VOLTAGES
(Curves Offset for Clarity)

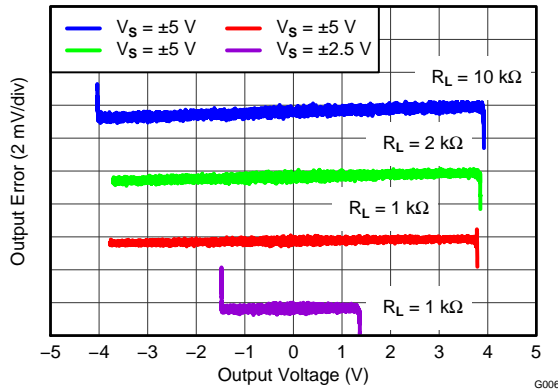

Figure 8.

GAIN NONLINEARITY

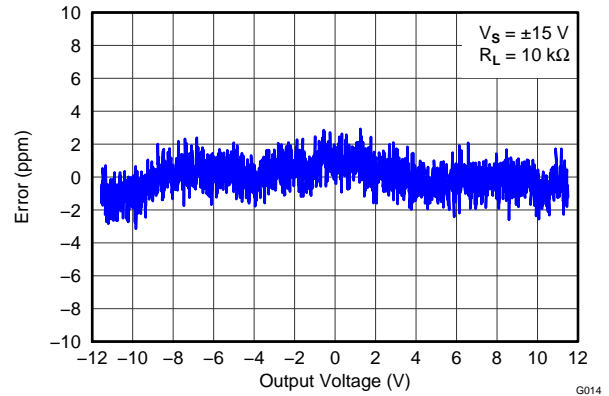

Figure 9.

GAIN NONLINEARITY

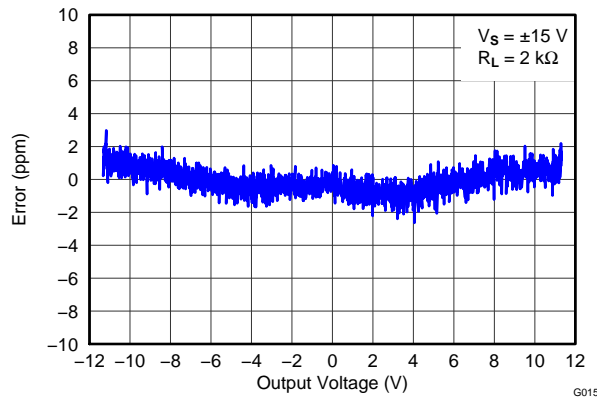

Figure 10.

GAIN NONLINEARITY

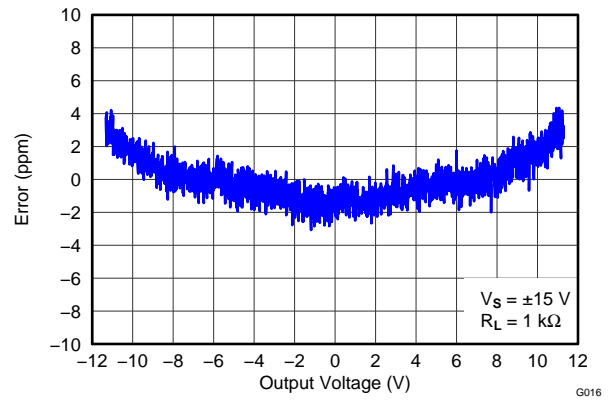

Figure 11.

GAIN NONLINEARITY

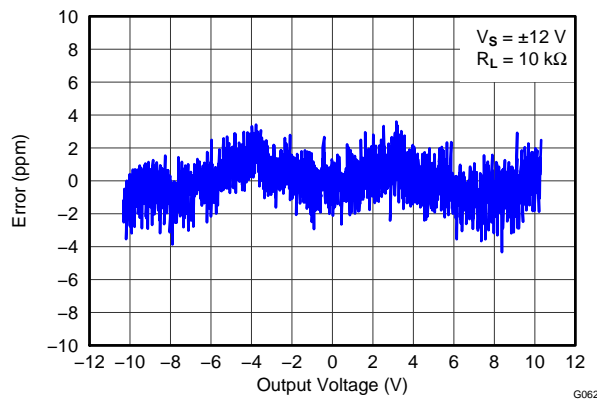

Figure 12.

OUTPUT VOLTAGE vs LOAD CURRENT

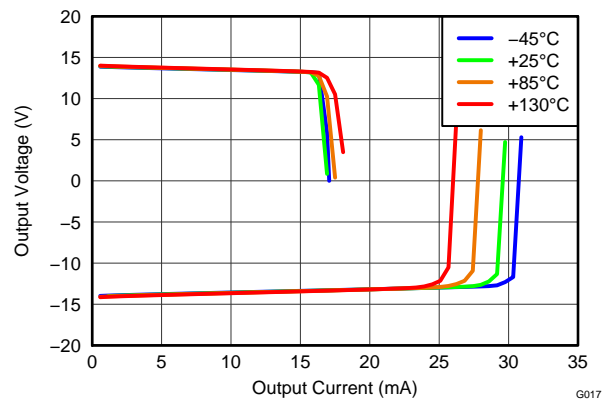

Figure 13.

TYPICAL CHARACTERISTICS (continued)

At $T_A = +25^\circ\text{C}$, $R_L = 2\text{ k}\Omega$ connected to ground, and $V_S = \pm 15\text{ V}$, unless otherwise noted.

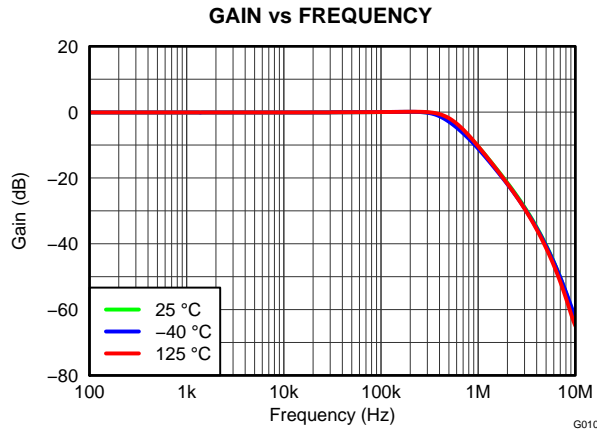

Figure 14.

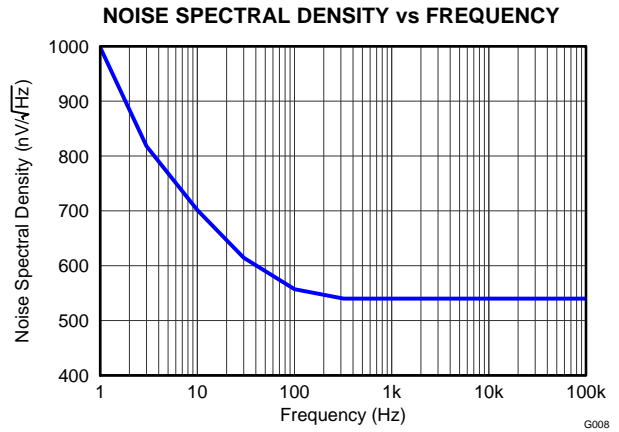

Figure 15.

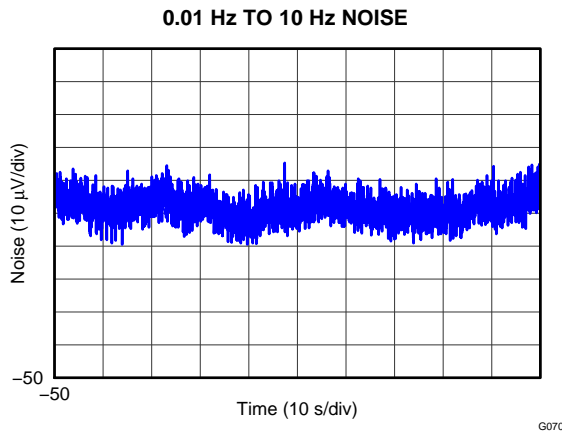

Figure 16.

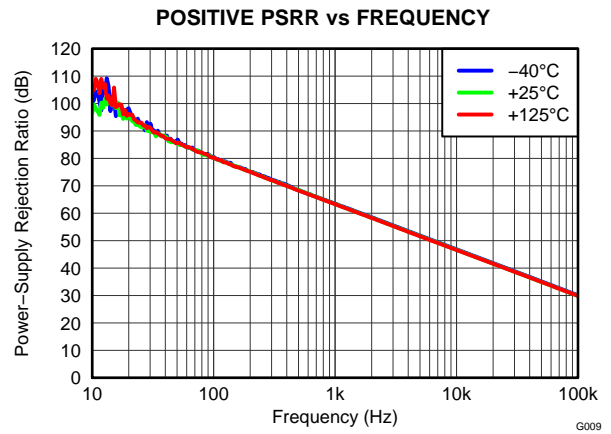

Figure 17.

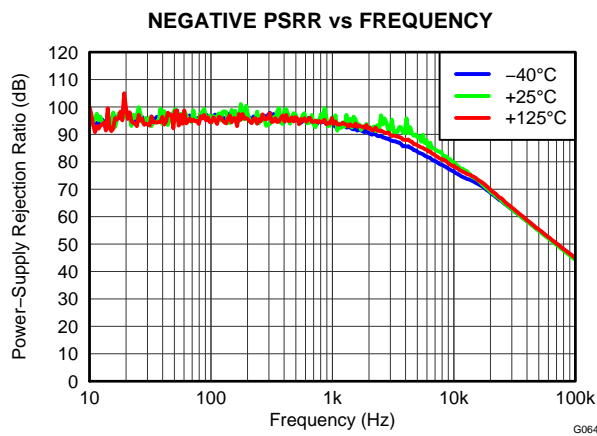

Figure 18.

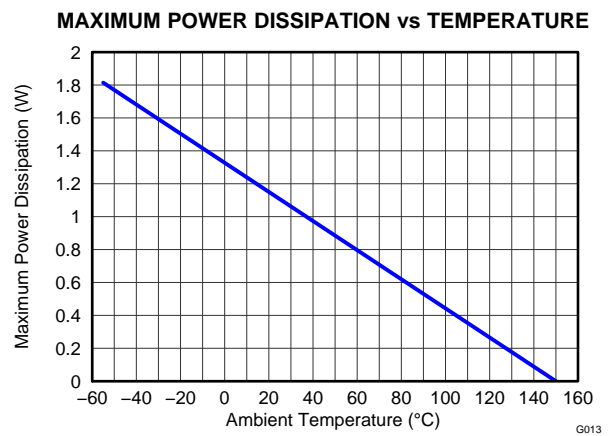

Figure 19.

TYPICAL CHARACTERISTICS (continued)

At $T_A = +25^\circ\text{C}$, $R_L = 2\text{ k}\Omega$ connected to ground, and $V_S = \pm 15\text{ V}$, unless otherwise noted.

LARGE-SIGNAL STEP RESPONSE

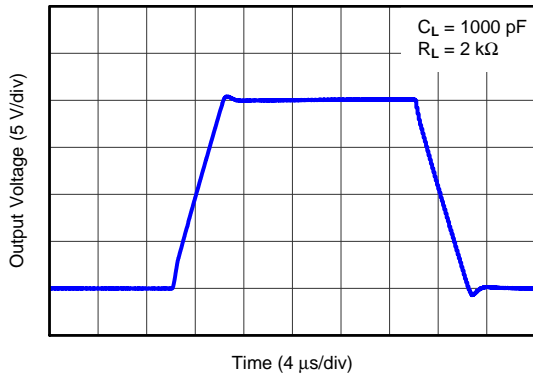

Figure 20.

G011

SMALL-SIGNAL STEP RESPONSE

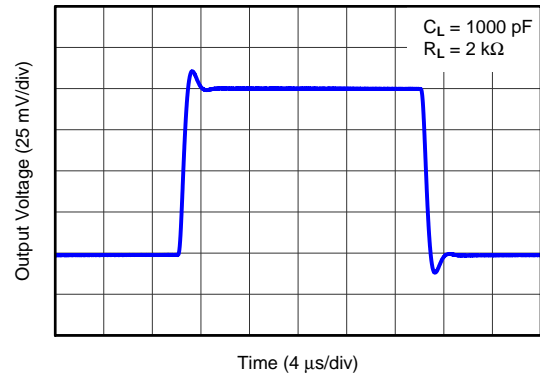

Figure 21.

G012

SMALL-SIGNAL RESPONSE vs CAPACITIVE LOAD

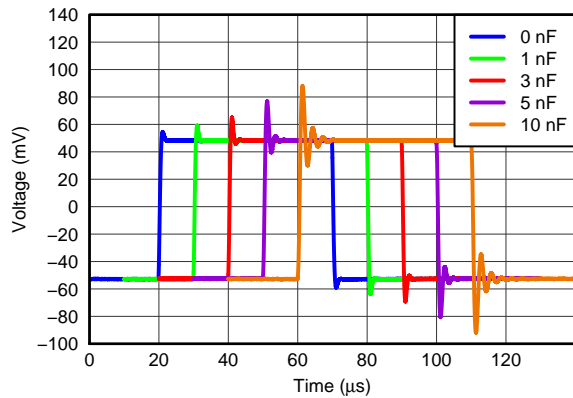

Figure 22.

G065

SETTLING TIME

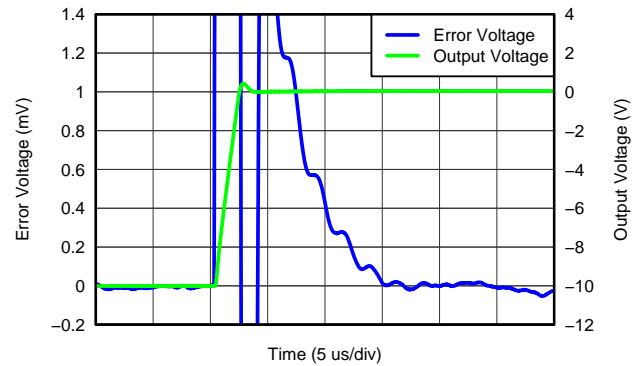

Figure 23.

G018

SETTLING TIME

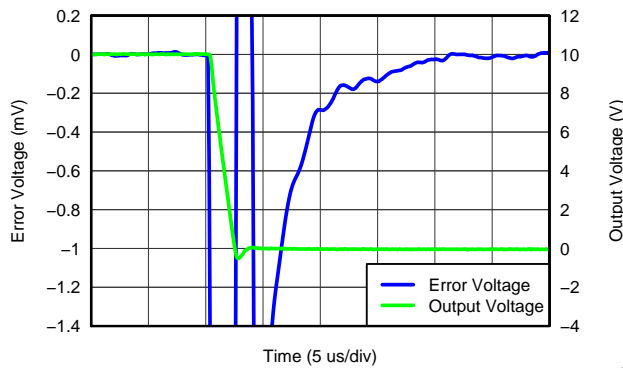

Figure 24.

G063

CMRR HISTOGRAM

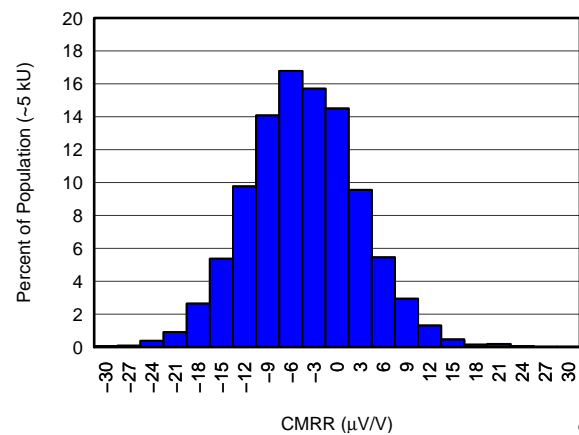

Figure 25.

G019

TYPICAL CHARACTERISTICS (continued)

At $T_A = +25^\circ\text{C}$, $R_L = 2\text{ k}\Omega$ connected to ground, and $V_S = \pm 15\text{ V}$, unless otherwise noted.

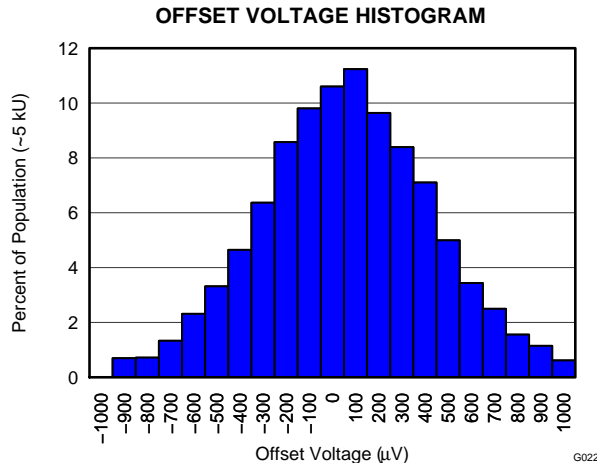

Figure 26.

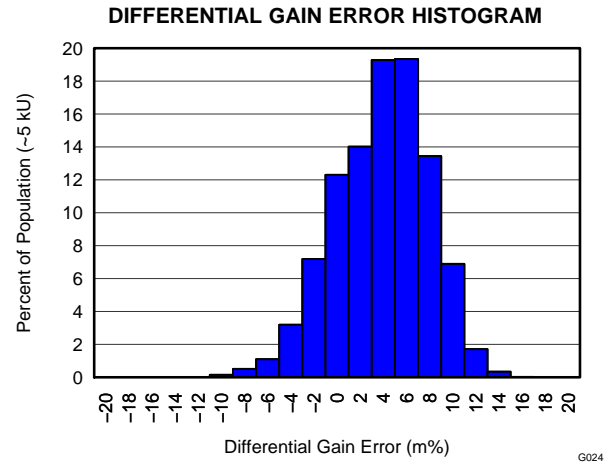

Figure 27.

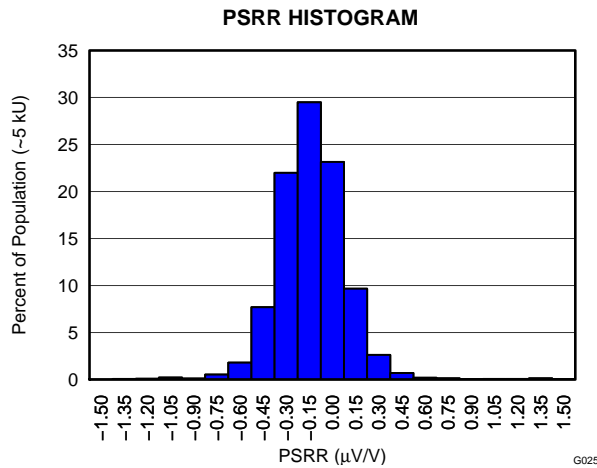

Figure 28.

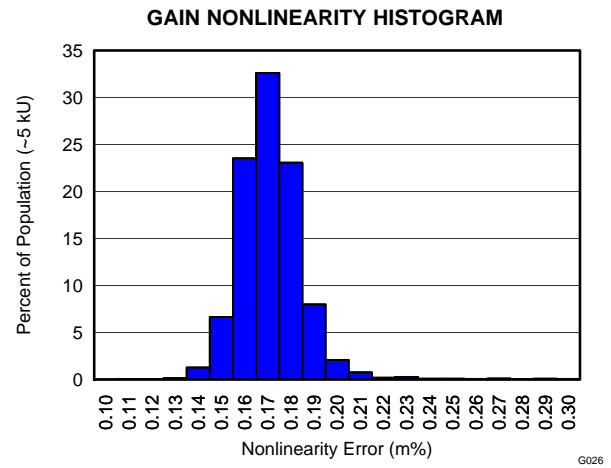

Figure 29.

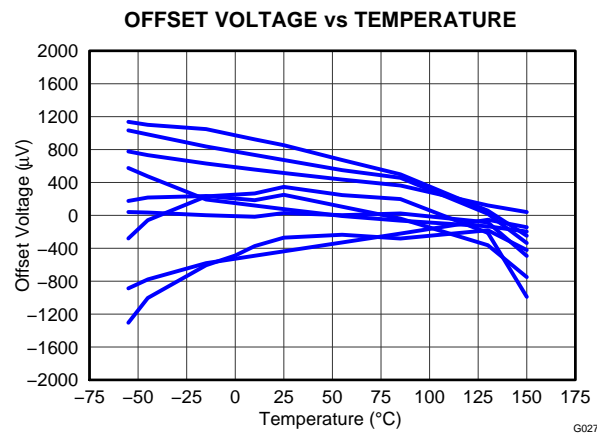

Figure 30.

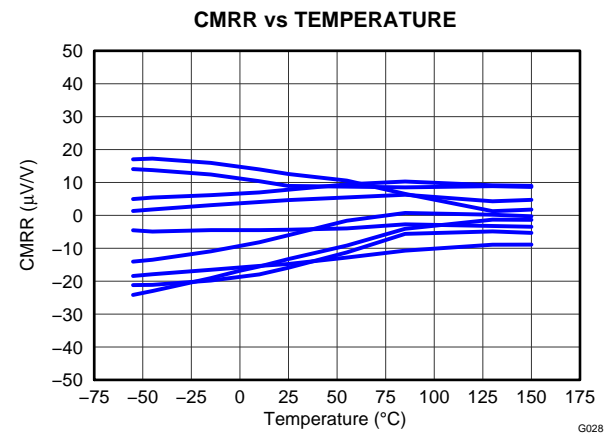

Figure 31.

TYPICAL CHARACTERISTICS (continued)

At $T_A = +25^\circ\text{C}$, $R_L = 2\text{ k}\Omega$ connected to ground, and $V_S = \pm 15\text{ V}$, unless otherwise noted.

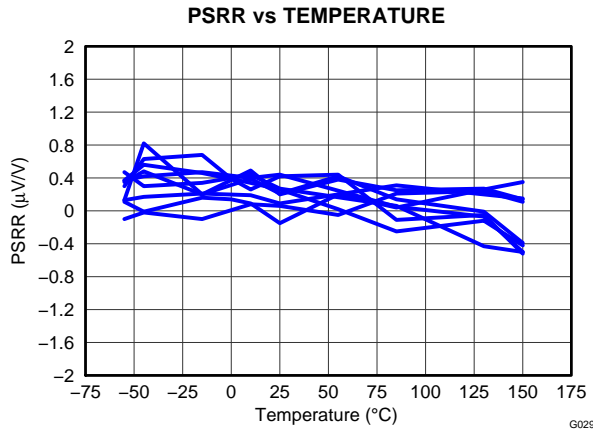

Figure 32.

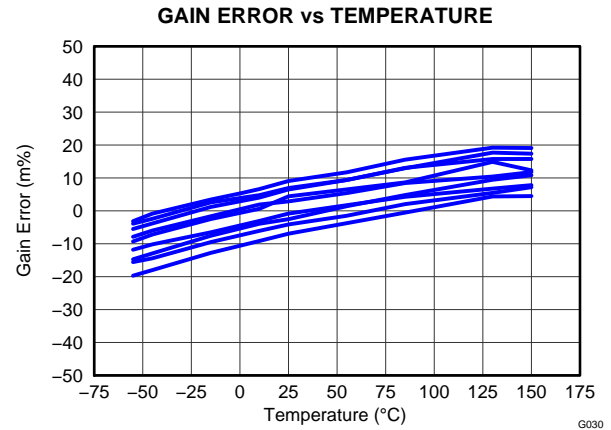

Figure 33.

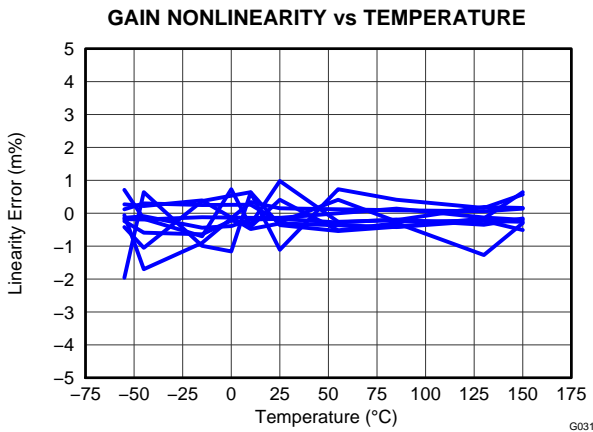

Figure 34.

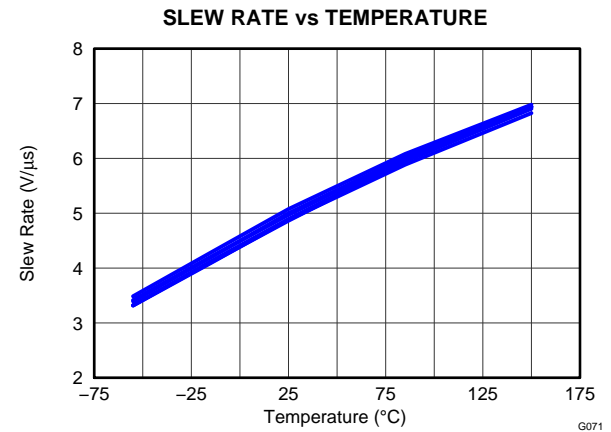

Figure 35.

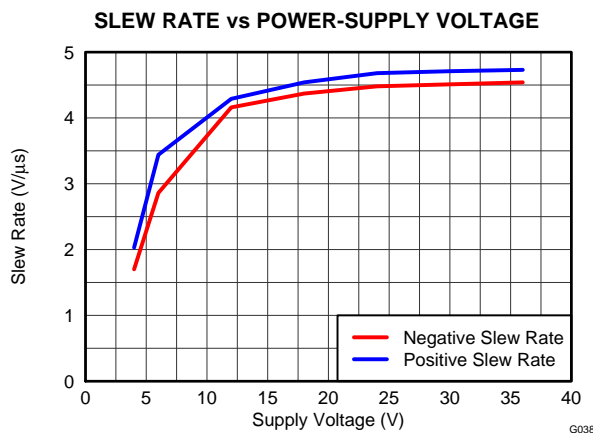

Figure 36.

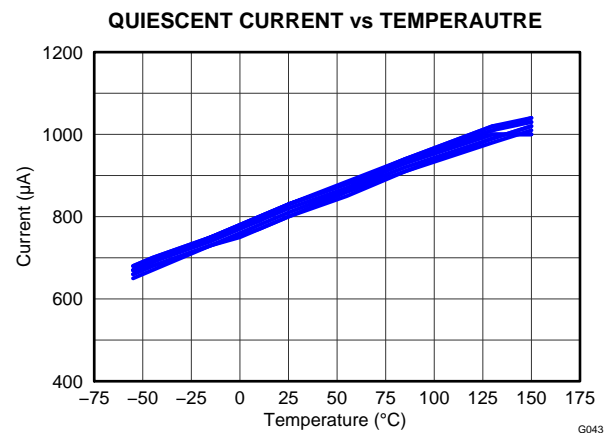

Figure 37.

TYPICAL CHARACTERISTICS (continued)

At $T_A = +25^\circ\text{C}$, $R_L = 2\text{ k}\Omega$ connected to ground, and $V_S = \pm 15\text{ V}$, unless otherwise noted.

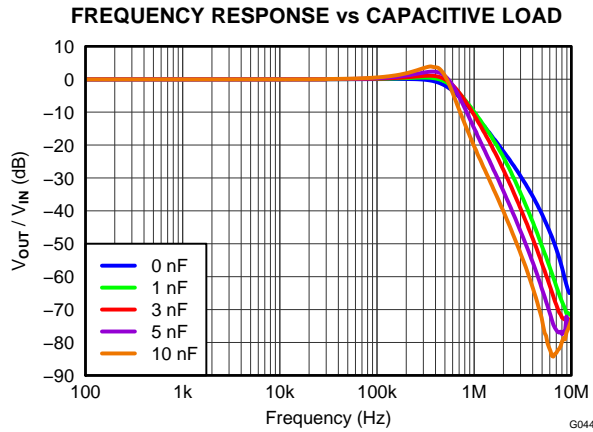

Figure 38.

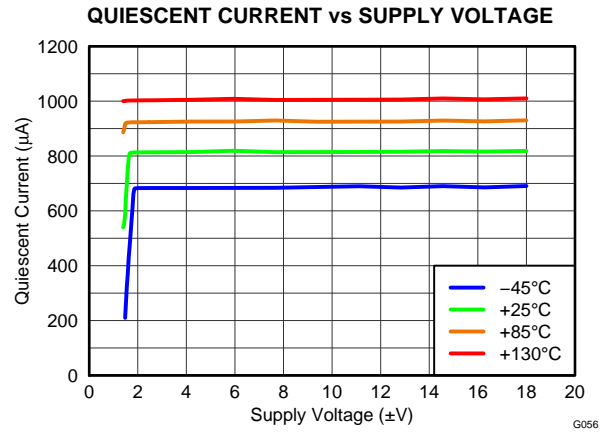

Figure 39.

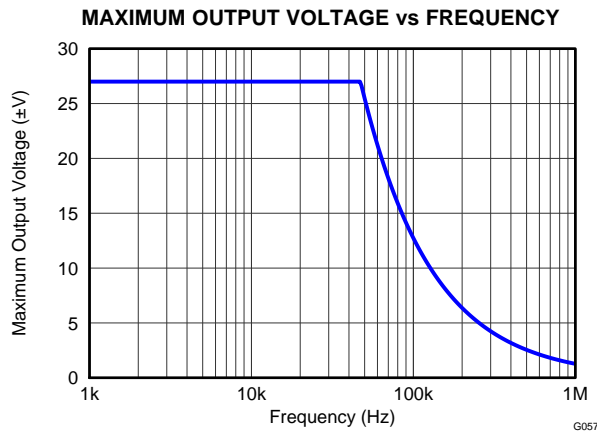

Figure 40.

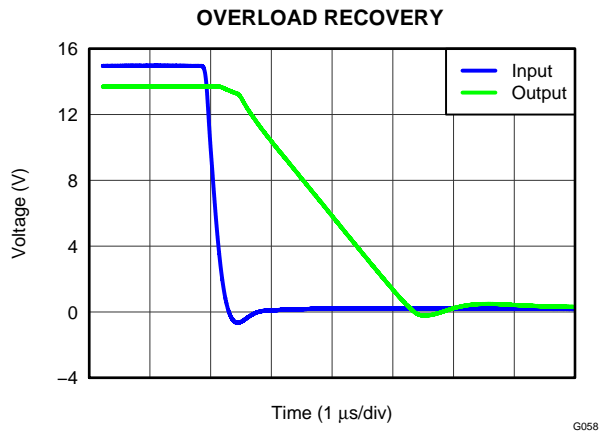

Figure 41.

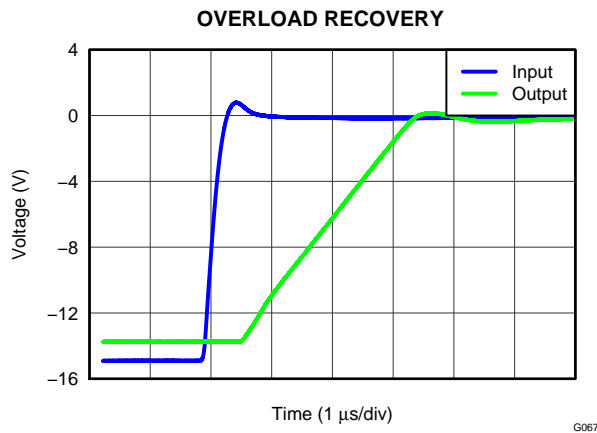

Figure 42.

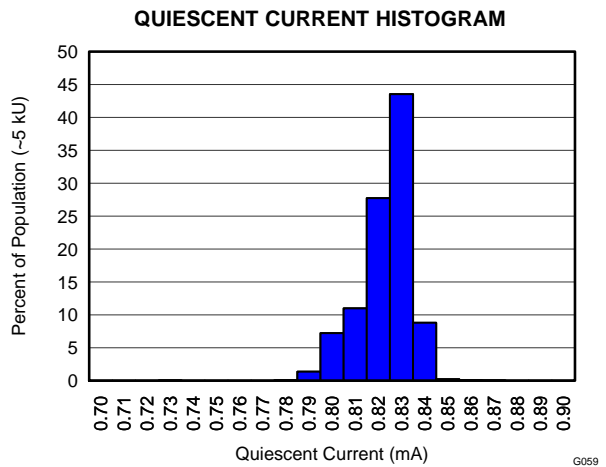

Figure 43.

APPLICATION INFORMATION

BASIC INFORMATION

Figure 44 shows the basic connections required for dual-supply operation. Applications with noisy or high-impedance power-supply lines may require decoupling capacitors placed close to the device pins. The output voltage is equal to the differential input voltage between pins 2 and 3. The common-mode input voltage is rejected. Figure 45 shows the basic connections required for single-supply operation.

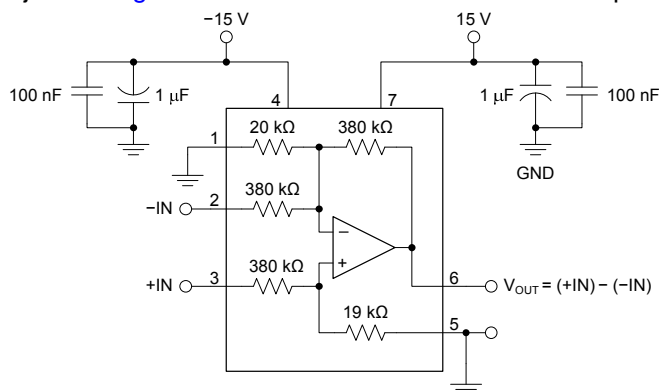

Figure 44. Basic Power and Signal Connections for Dual-Supply Operation

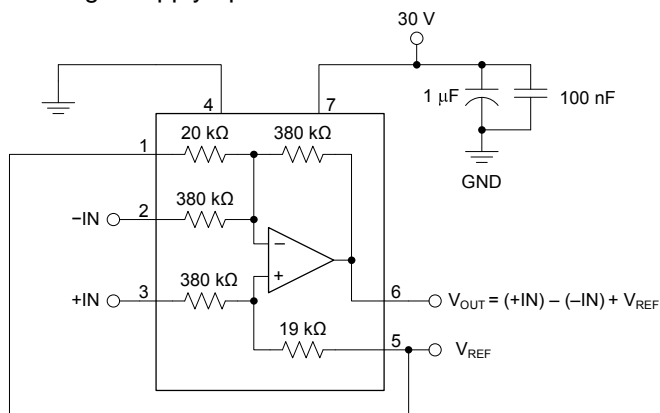

Figure 45. Basic Power and Signal Connections for Single-Supply Operation

TRANSFER FUNCTION

Most applications use the INA149 as a simple unity-gain difference amplifier. The transfer function is given in Equation 1:

$$V_{OUT} = (+IN) - (-IN) \quad (1)$$

Some applications, however, apply voltages to the reference terminals (REF_A and REF_B). The complete transfer function is given in Equation 2:

$$V_{OUT} = (+IN) - (-IN) + 20 \times REF_A - 19 \times REF_B \quad (2)$$

COMMON-MODE RANGE

The high common-mode range of the INA149 is achieved by dividing down the input signal with a high precision resistor divider. This resistor divider brings both the positive input and the negative input within the input range of the internal operational amplifier. This input range depends on the supply voltage of the INA149.

Both Figure 3 and Figure 4 can be used to determine the maximum common-mode range for a specific supply voltage. The maximum common-mode range can also be calculated by ensuring that both the positive and the negative input of the internal amplifier are within 1.5 V of the supply voltage.

In case the voltage at the inputs of the internal amplifier exceeds the supply voltage, the internal ESD diodes start conducting current. This current must be limited to 10 mA to make sure not to exceed the absolute maximum ratings for the device.

COMMON-MODE REJECTION

Common-mode rejection (CMR) of the INA149 depends on the input resistor network, which is laser-trimmed for accurate ratio matching. To maintain high CMR, it is important to have low source impedance driving the two inputs. A 75-Ω resistance in series with pins 2 or 3 decreases the common-mode rejection ratio (CMRR) from 100 dB (typical) to 74 dB.

Resistance in series with the reference pins also degrades CMR. A 4-Ω resistance in series with pins 1 or 5 decreases CMRR from 100 dB to 74 dB.

Most applications do not require trimming. Figure 46 shows an optional circuit that may be used for trimming offset voltage and common-mode rejection.

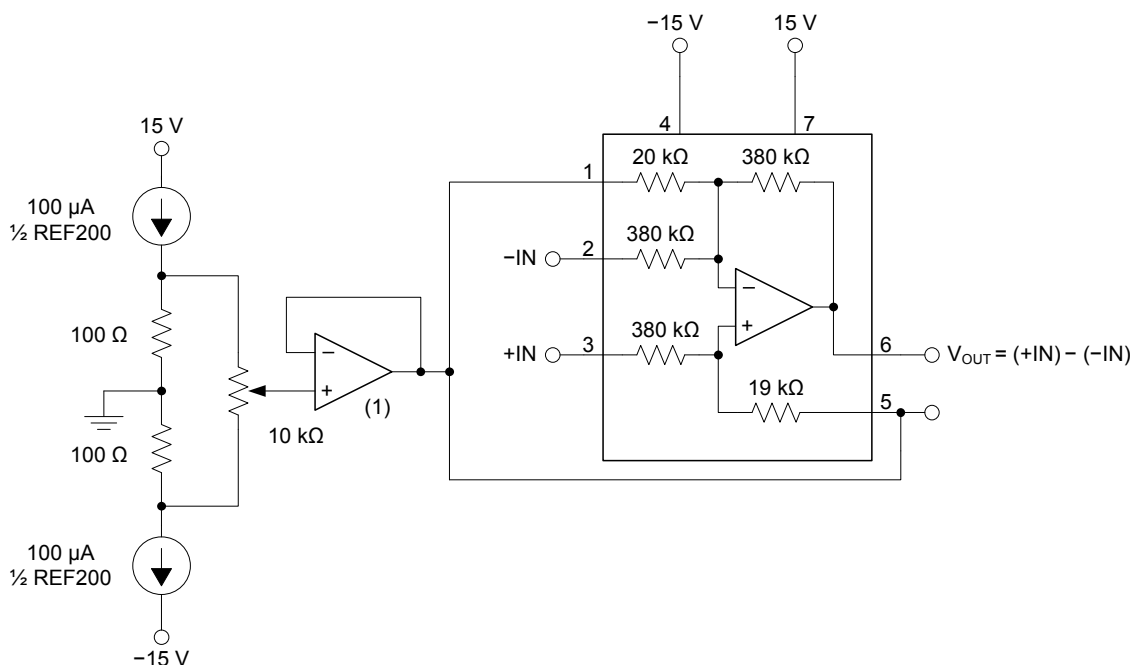

(1) The OPA171 (a 36-V, low-power, RRO, general-purpose operational amplifier) can be used for this application.

Figure 46. Offset Voltage Trim Circuit

MEASURING CURRENT

The INA149 can be used to measure a current by sensing the voltage drop across a series resistor, R_S . Figure 47 shows the INA149 used to measure the supply currents of a device under test.

The sense resistor imbalances the input resistor matching of the INA149, thus degrading its CMR. Also, the input impedance of the INA149 loads R_S , causing gain error in the voltage-to-current conversion. Both of these errors can be easily corrected.

The CMR error can be corrected with the addition of a compensation resistor (R_C), equal to the value of R_S , as shown in Figure 47. If R_S is less than 5 Ω , degradation in the CMR is negligible and R_C can be omitted. If R_S is larger than approximately 1 k Ω , trimming R_C may be required to achieve greater than 84-dB CMR. This error is caused by the INA149 input impedance mismatch.

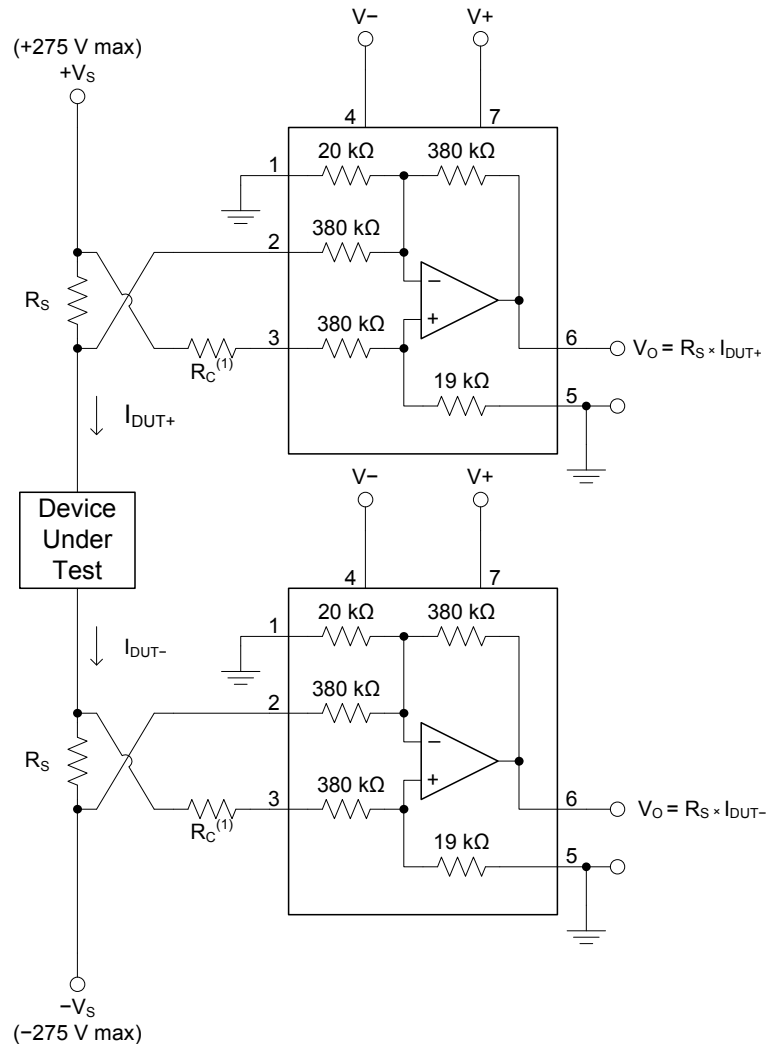

Figure 47. Measuring Supply Currents of a Device Under Test

If R_S is more than approximately 50 Ω , the gain error is greater than the 0.02% specification of the INA149. This gain error can be corrected by slightly increasing the value of R_S . The corrected value (R_S') can be calculated by $R_S' = R_S \times 380 \text{ k}\Omega / (380 \text{ k}\Omega - R_S)$ (3)

NOISE PERFORMANCE

The wideband noise performance of the INA149 is dominated by the internal resistor network. The thermal or *Johnson noise* of these resistors measures approximately 550 nV/√Hz. The internal op amp contributes virtually no excess noise at frequencies above 100 Hz.

Many applications may be satisfied with less than the full 500-kHz bandwidth of the INA149. In these cases, the noise can be reduced with a low-pass filter on the output. The two-pole filter shown in Figure 48 limits bandwidth and reduces noise. Because the INA149 has a 1/f noise corner frequency of approximately 100 Hz, a cutoff frequency below 100 Hz does not further reduce noise.

Component values for different filter frequencies are shown in Table 1.

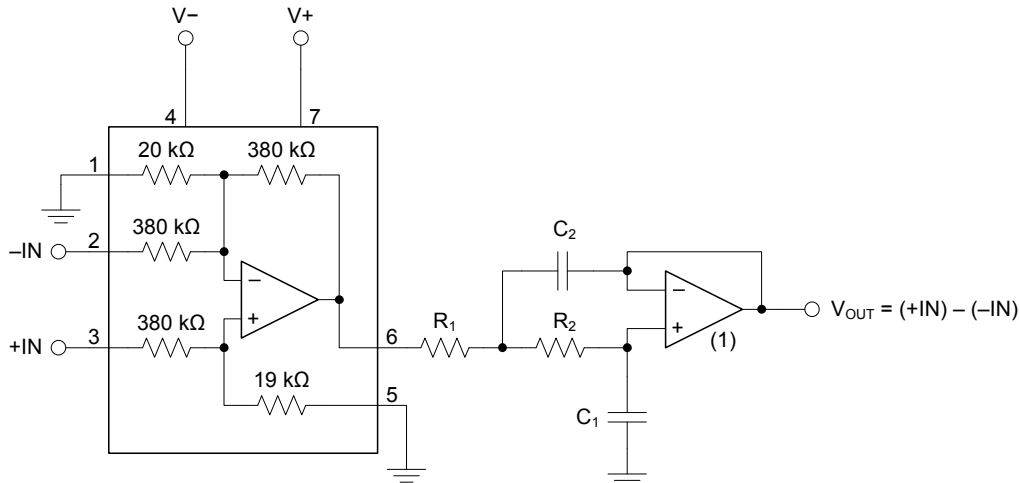

(1) For most applications, the OPA171 can be used as an operational amplifier. For directly driving successive-approximation register (SAR) data converters, the OPA140 is a good choice.

Figure 48. Output Filter for Noise Reduction

Table 1. Components Values for Different Filter Bandwidths

BUTTERWORTH LOW-PASS (f _{-3 dB})	OUTPUT NOISE (mV _{PP})	R ₁	R ₂	C ₁	C ₂
200 kHz	1.8	No filter			
100 kHz	1.1	11 kΩ	11.3 kΩ	100 pF	200 pF
10 kHz	0.35	11 kΩ	11.3 kΩ	1 nF	2 nF
1 kHz	0.11	11 kΩ	11.3 kΩ	10 nF	20 nF
100 Hz	0.05	11 kΩ	11.3 kΩ	0.1 μF	0.2 μF

BATTERY CELL VOLTAGE MONITOR

The INA149 can be used to measure the voltages of single cells in a stacked battery pack. Figure 49 shows an examples for such an application.

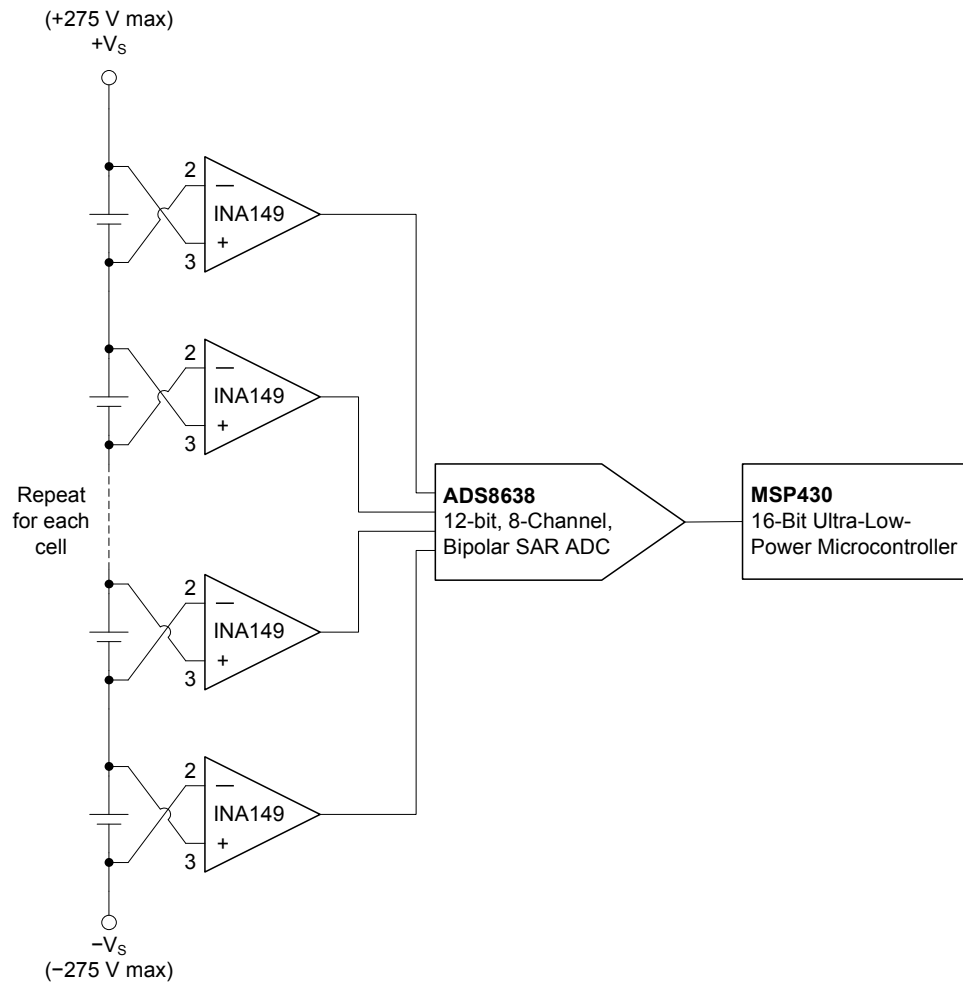

Figure 49. Battery Cell Voltage Monitor

PACKAGING INFORMATION

Orderable Device	Status (1)	Package Type	Package Drawing	Pins	Package Qty	Eco Plan (2)	Lead/Ball Finish	MSL Peak Temp (3)	Op Temp (°C)	Top-Side Markings (4)	Samples
INA149AMDREP	ACTIVE	SOIC	D	8	2500	Green (RoHS & no Sb/Br)	CU NIPDAU	Level-2-260C-1 YEAR	-55 to 125	INA 149AM	Samples
V62/12614-01XE	ACTIVE	SOIC	D	8	2500	Green (RoHS & no Sb/Br)	CU NIPDAU	Level-2-260C-1 YEAR	-55 to 125	INA 149AM	Samples

(1) The marketing status values are defined as follows:

ACTIVE: Product device recommended for new designs.

LIFEBUY: TI has announced that the device will be discontinued, and a lifetime-buy period is in effect.

NRND: Not recommended for new designs. Device is in production to support existing customers, but TI does not recommend using this part in a new design.

PREVIEW: Device has been announced but is not in production. Samples may or may not be available.

OBSOLETE: TI has discontinued the production of the device.

(2) Eco Plan - The planned eco-friendly classification: Pb-Free (RoHS), Pb-Free (RoHS Exempt), or Green (RoHS & no Sb/Br) - please check <http://www.ti.com/productcontent> for the latest availability information and additional product content details.

TBD: The Pb-Free/Green conversion plan has not been defined.

Pb-Free (RoHS): TI's terms "Lead-Free" or "Pb-Free" mean semiconductor products that are compatible with the current RoHS requirements for all 6 substances, including the requirement that lead not exceed 0.1% by weight in homogeneous materials. Where designed to be soldered at high temperatures, TI Pb-Free products are suitable for use in specified lead-free processes.

Pb-Free (RoHS Exempt): This component has a RoHS exemption for either 1) lead-based flip-chip solder bumps used between the die and package, or 2) lead-based die adhesive used between the die and leadframe. The component is otherwise considered Pb-Free (RoHS compatible) as defined above.

Green (RoHS & no Sb/Br): TI defines "Green" to mean Pb-Free (RoHS compatible), and free of Bromine (Br) and Antimony (Sb) based flame retardants (Br or Sb do not exceed 0.1% by weight in homogeneous material)

(3) MSL, Peak Temp. -- The Moisture Sensitivity Level rating according to the JEDEC industry standard classifications, and peak solder temperature.

(4) Multiple Top-Side Markings will be inside parentheses. Only one Top-Side Marking contained in parentheses and separated by a "~" will appear on a device. If a line is indented then it is a continuation of the previous line and the two combined represent the entire Top-Side Marking for that device.

Important Information and Disclaimer: The information provided on this page represents TI's knowledge and belief as of the date that it is provided. TI bases its knowledge and belief on information provided by third parties, and makes no representation or warranty as to the accuracy of such information. Efforts are underway to better integrate information from third parties. TI has taken and continues to take reasonable steps to provide representative and accurate information but may not have conducted destructive testing or chemical analysis on incoming materials and chemicals. TI and TI suppliers consider certain information to be proprietary, and thus CAS numbers and other limited information may not be available for release.

In no event shall TI's liability arising out of such information exceed the total purchase price of the TI part(s) at issue in this document sold by TI to Customer on an annual basis.

OTHER QUALIFIED VERSIONS OF INA149-EP :

- Catalog: [INA149](#)

NOTE: Qualified Version Definitions:

- Catalog - TI's standard catalog product

TAPE AND REEL INFORMATION

REEL DIMENSIONS

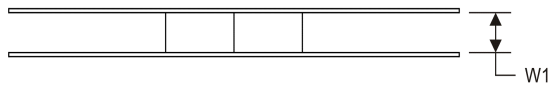
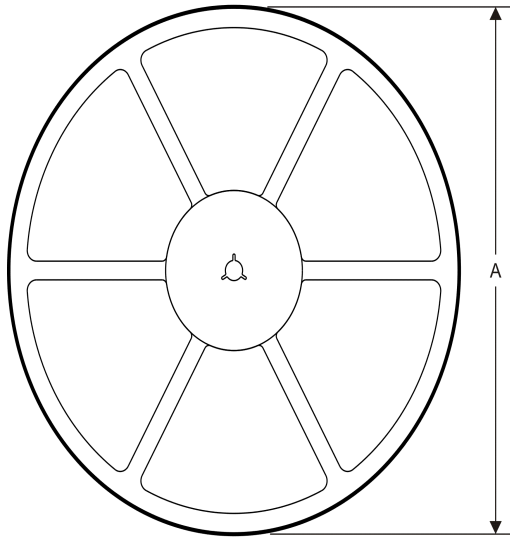

TAPE DIMENSIONS

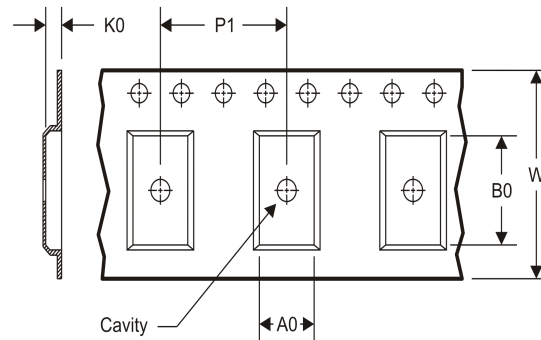

A0	Dimension designed to accommodate the component width
B0	Dimension designed to accommodate the component length
K0	Dimension designed to accommodate the component thickness
W	Overall width of the carrier tape
P1	Pitch between successive cavity centers

TAPE AND REEL INFORMATION

*All dimensions are nominal

Device	Package Type	Package Drawing	Pins	SPQ	Reel Diameter (mm)	Reel Width W1 (mm)	A0 (mm)	B0 (mm)	K0 (mm)	P1 (mm)	W (mm)	Pin1 Quadrant
INA149AMDREP	SOIC	D	8	2500	330.0	12.4	6.4	5.2	2.1	8.0	12.0	Q1

TAPE AND REEL BOX DIMENSIONS



*All dimensions are nominal

Device	Package Type	Package Drawing	Pins	SPQ	Length (mm)	Width (mm)	Height (mm)
INA149AMDREP	SOIC	D	8	2500	367.0	367.0	35.0

D (R-PDSO-G8)

PLASTIC SMALL OUTLINE

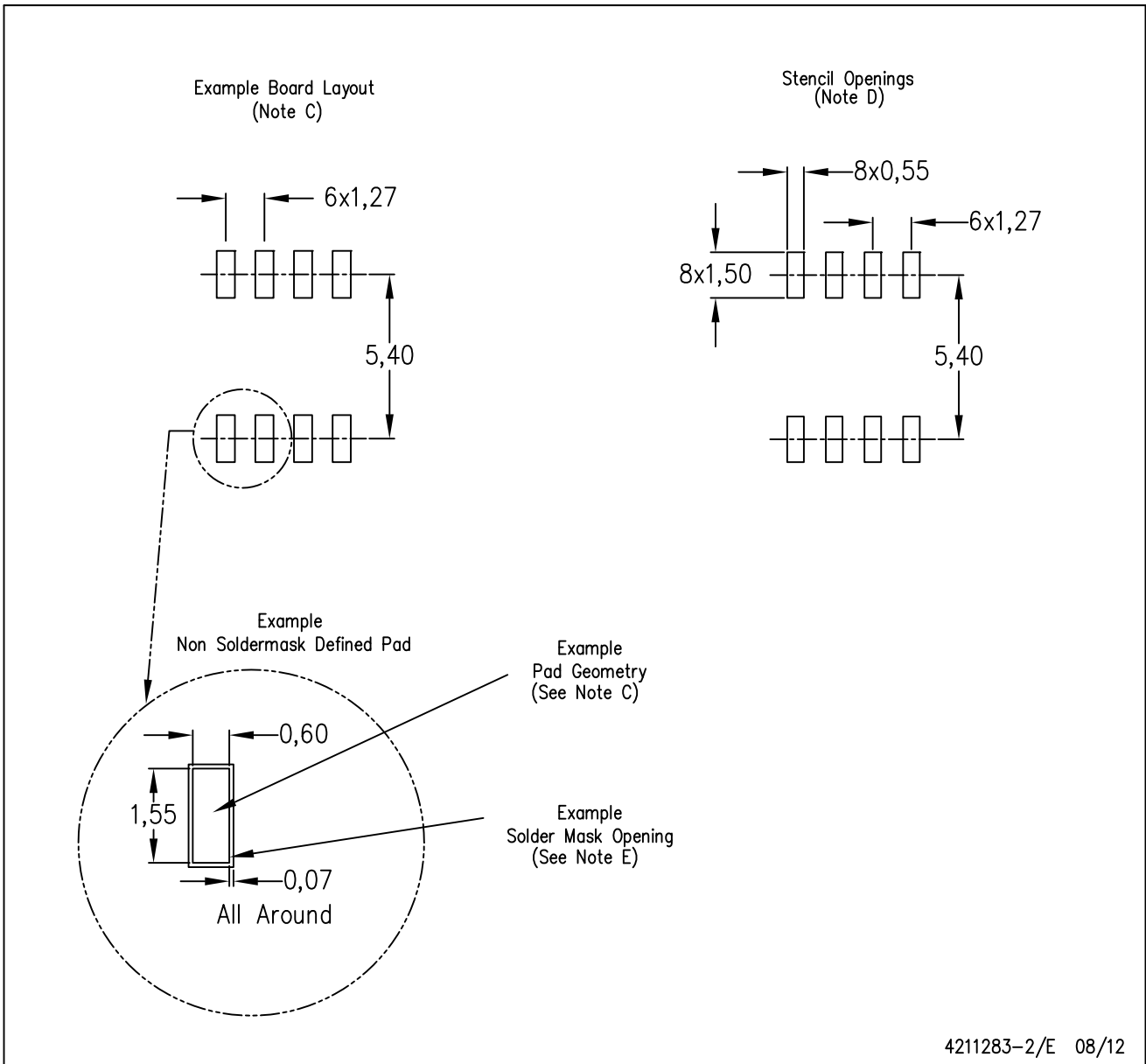

4211283-2/E 08/12

- NOTES:
- A. All linear dimensions are in millimeters.
 - B. This drawing is subject to change without notice.
 - C. Publication IPC-7351 is recommended for alternate designs.
 - D. Laser cutting apertures with trapezoidal walls and also rounding corners will offer better paste release. Customers should contact their board assembly site for stencil design recommendations. Refer to IPC-7525 for other stencil recommendations.
 - E. Customers should contact their board fabrication site for solder mask tolerances between and around signal pads.

IMPORTANT NOTICE

Texas Instruments Incorporated and its subsidiaries (TI) reserve the right to make corrections, enhancements, improvements and other changes to its semiconductor products and services per JESD46, latest issue, and to discontinue any product or service per JESD48, latest issue. Buyers should obtain the latest relevant information before placing orders and should verify that such information is current and complete. All semiconductor products (also referred to herein as "components") are sold subject to TI's terms and conditions of sale supplied at the time of order acknowledgment.

TI warrants performance of its components to the specifications applicable at the time of sale, in accordance with the warranty in TI's terms and conditions of sale of semiconductor products. Testing and other quality control techniques are used to the extent TI deems necessary to support this warranty. Except where mandated by applicable law, testing of all parameters of each component is not necessarily performed.

TI assumes no liability for applications assistance or the design of Buyers' products. Buyers are responsible for their products and applications using TI components. To minimize the risks associated with Buyers' products and applications, Buyers should provide adequate design and operating safeguards.

TI does not warrant or represent that any license, either express or implied, is granted under any patent right, copyright, mask work right, or other intellectual property right relating to any combination, machine, or process in which TI components or services are used. Information published by TI regarding third-party products or services does not constitute a license to use such products or services or a warranty or endorsement thereof. Use of such information may require a license from a third party under the patents or other intellectual property of the third party, or a license from TI under the patents or other intellectual property of TI.

Reproduction of significant portions of TI information in TI data books or data sheets is permissible only if reproduction is without alteration and is accompanied by all associated warranties, conditions, limitations, and notices. TI is not responsible or liable for such altered documentation. Information of third parties may be subject to additional restrictions.

Resale of TI components or services with statements different from or beyond the parameters stated by TI for that component or service voids all express and any implied warranties for the associated TI component or service and is an unfair and deceptive business practice. TI is not responsible or liable for any such statements.

Buyer acknowledges and agrees that it is solely responsible for compliance with all legal, regulatory and safety-related requirements concerning its products, and any use of TI components in its applications, notwithstanding any applications-related information or support that may be provided by TI. Buyer represents and agrees that it has all the necessary expertise to create and implement safeguards which anticipate dangerous consequences of failures, monitor failures and their consequences, lessen the likelihood of failures that might cause harm and take appropriate remedial actions. Buyer will fully indemnify TI and its representatives against any damages arising out of the use of any TI components in safety-critical applications.

In some cases, TI components may be promoted specifically to facilitate safety-related applications. With such components, TI's goal is to help enable customers to design and create their own end-product solutions that meet applicable functional safety standards and requirements. Nonetheless, such components are subject to these terms.

No TI components are authorized for use in FDA Class III (or similar life-critical medical equipment) unless authorized officers of the parties have executed a special agreement specifically governing such use.

Only those TI components which TI has specifically designated as military grade or "enhanced plastic" are designed and intended for use in military/aerospace applications or environments. Buyer acknowledges and agrees that any military or aerospace use of TI components which have **not** been so designated is solely at the Buyer's risk, and that Buyer is solely responsible for compliance with all legal and regulatory requirements in connection with such use.

TI has specifically designated certain components as meeting ISO/TS16949 requirements, mainly for automotive use. In any case of use of non-designated products, TI will not be responsible for any failure to meet ISO/TS16949.

Products

Audio	www.ti.com/audio
Amplifiers	amplifier.ti.com
Data Converters	dataconverter.ti.com
DLP® Products	www.dlp.com
DSP	dsp.ti.com
Clocks and Timers	www.ti.com/clocks
Interface	interface.ti.com
Logic	logic.ti.com
Power Mgmt	power.ti.com
Microcontrollers	microcontroller.ti.com
RFID	www.ti-rfid.com
OMAP Applications Processors	www.ti.com/omap
Wireless Connectivity	www.ti.com/wirelessconnectivity

Applications

Automotive and Transportation	www.ti.com/automotive
Communications and Telecom	www.ti.com/communications
Computers and Peripherals	www.ti.com/computers
Consumer Electronics	www.ti.com/consumer-apps
Energy and Lighting	www.ti.com/energy
Industrial	www.ti.com/industrial
Medical	www.ti.com/medical
Security	www.ti.com/security
Space, Avionics and Defense	www.ti.com/space-avionics-defense
Video and Imaging	www.ti.com/video

TI E2E Community

e2e.ti.com